

Idébank – Givare, givarefästen mm

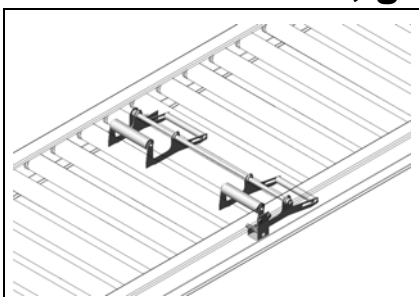

PA1500 – Indikeringsrulle
Typ INR *

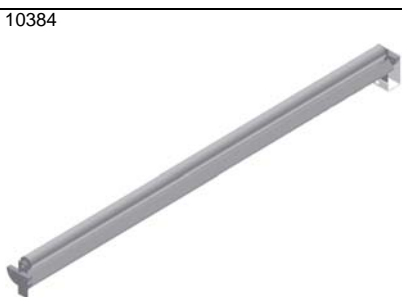

10384

PA1500 – Indikeringsrulle för
långa rullängder

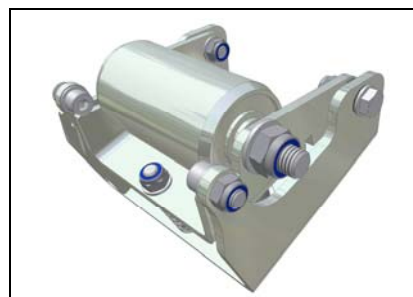

PA1500 – Indikeringsrulle

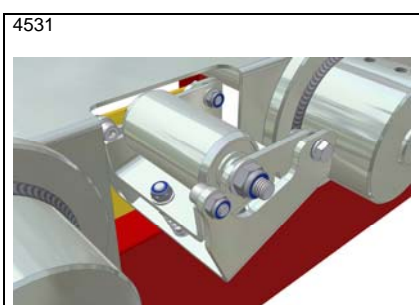

4531

Flänshjulbana - Indikeringsrulle

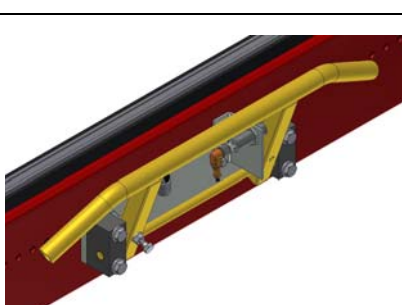

PA1500 – Indikeringssskena till
kedjetransportör



AX100 – Givarfäste insida spant
Typ GFIF *

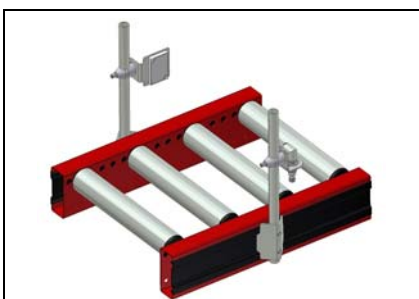

AX100 – Givarfäste utsida spant
Typ GFU *

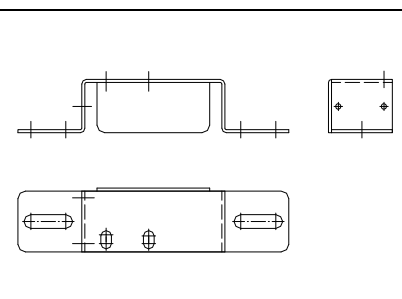

AX100 – Fotocellfäste

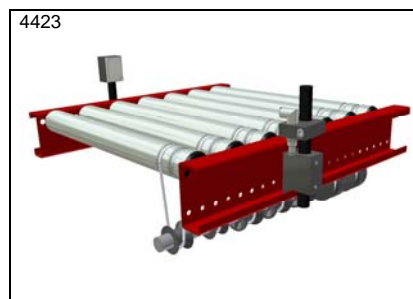

4423

AX100 – Fotocellfäste

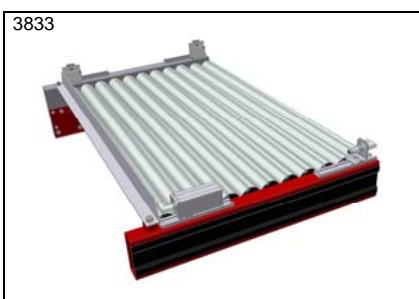

3833

KE100 – Fotocellfäste M18

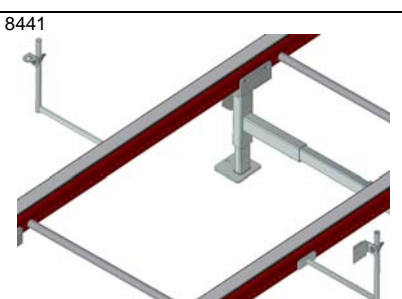

8441

KRT100 – Givarfästen utsida
spant

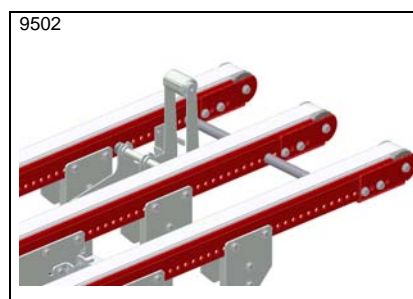

9502

KRT100 – Indikeringsrulle för
1/4-pall

* Datablad finns

Idébank – Givare, givarefästen mm

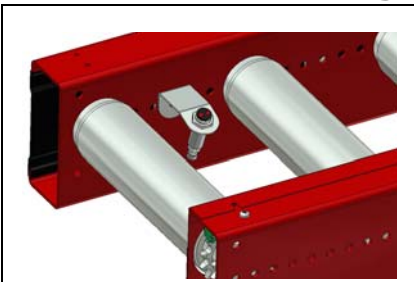

PA1500 – Givarfäste insida spant, fast Typ GFIF *



PA1500 – Givarfäste insida spant, justerbart Typ GFIJ *

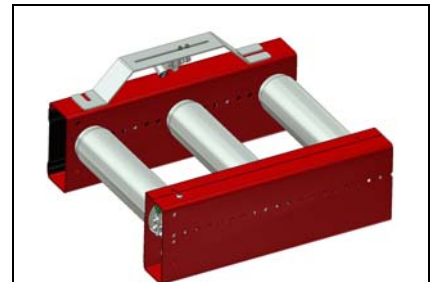

PA1500 – Givarfäste ovansida spant Typ GFO *

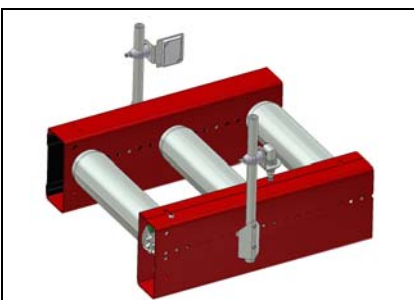

PA1500 – Givarfäste utsida spant Typ GFU *

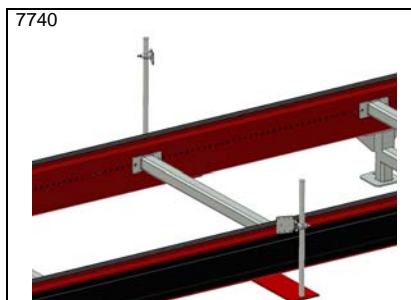

7740

PA1500 – Fästen för fotocell och reflex. Till kedjetransportör

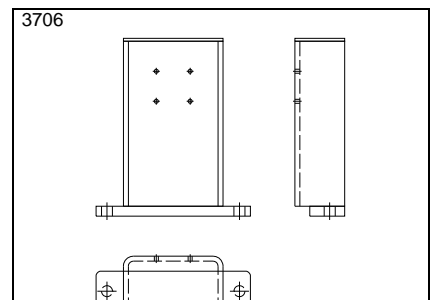

3706

PA1500 – Fotocellfäste

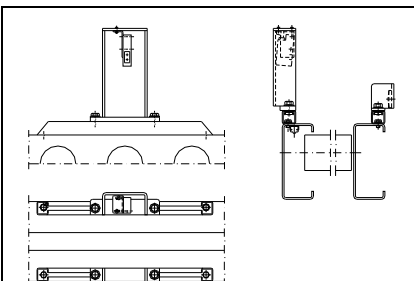

PA1500 – Fotocell och reflex med fästen



5753

PA1500 – Fotocell och reflex med fästen



Givarfäste för M18-givare.

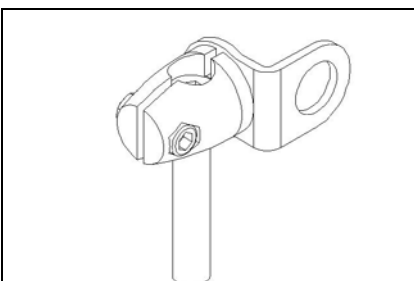

Givarfäste för M18-givare



Givarfäste för M18-givare.

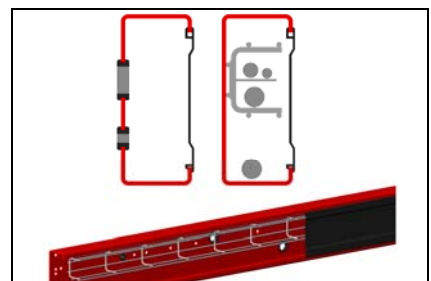

PA1500 – Kabelkanal i spant

* Datablad finns

Material Handling Modules AB

Österlenvägen 280
S-270 21 Glemmingebro

Tel. + 46 411 55 89 80
Fax. + 46 411 52 27 70

info@mhmodules.com
www.mhmodules.com

VAT: SE556490745801

Idébank – Givare, givarefästen mm

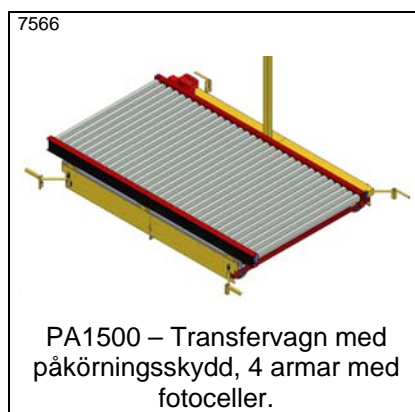
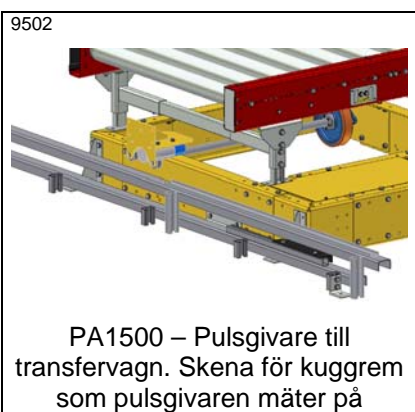
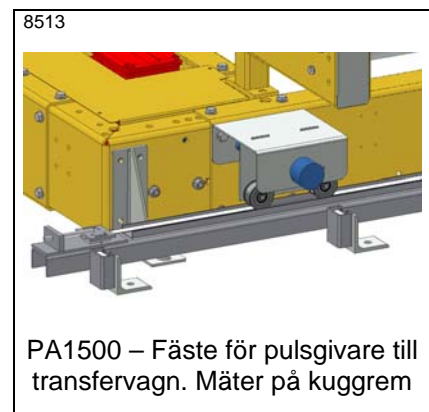
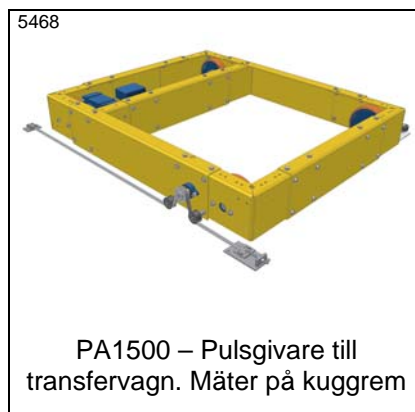
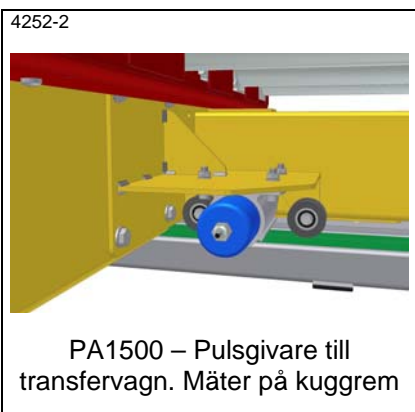
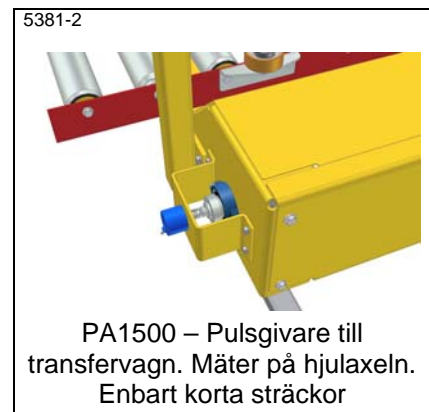
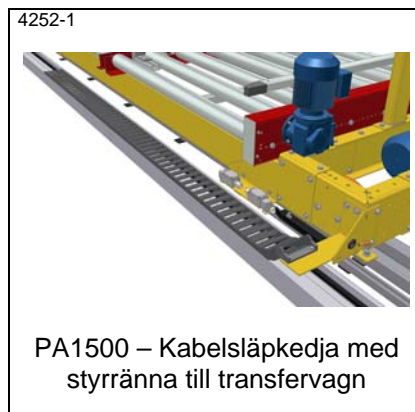
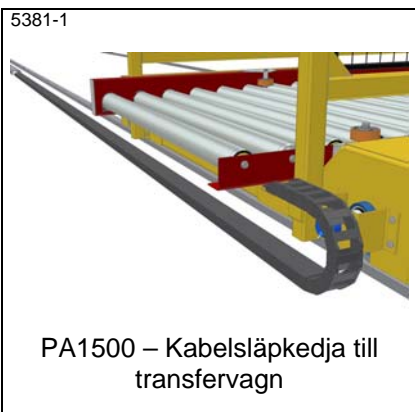

* Datablad finns