

AX100 – Vändare, elektrisk vridrörelse Typ VDM *

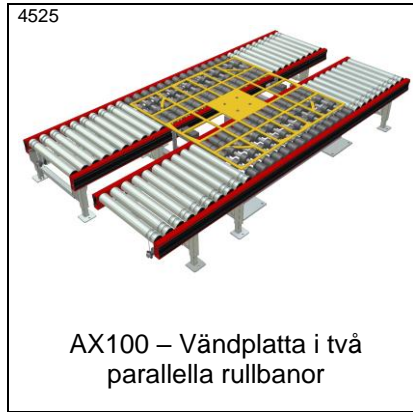

AX100 – Vändplatta i två parallella rullbanor

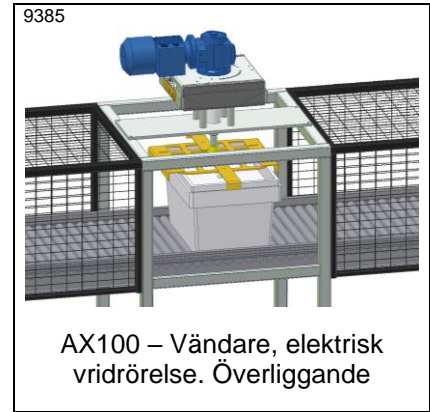

AX100 – Vändare, elektrisk vridrörelse. Överliggande

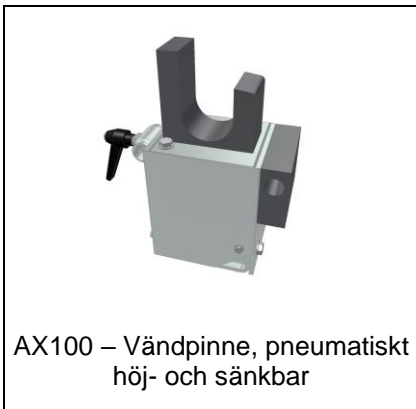

AX100 – Vändpinne, pneumatiskt höj- och sänkbar

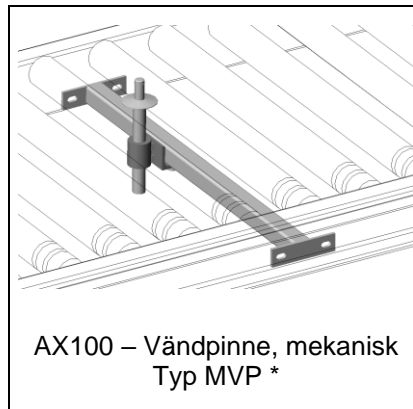

AX100 – Vändpinne, mekanisk Typ MVP *

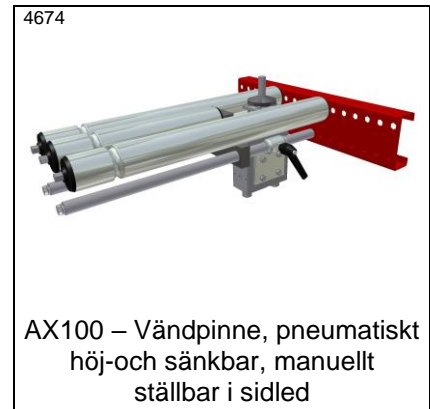

AX100 – Vändpinne, pneumatiskt höj- och sänkbar, manuellt ställbar i sidled

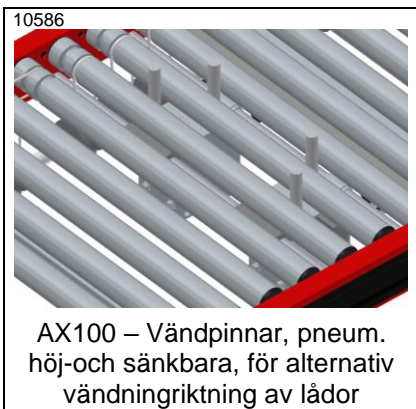

AX100 – Vändpinnar, pneum. höj- och sänkbara, för alternativ vändningriktning av lådor

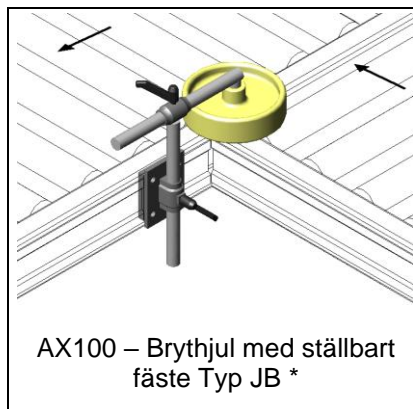

AX100 – Brythjul med ställbart fäste Typ JB *

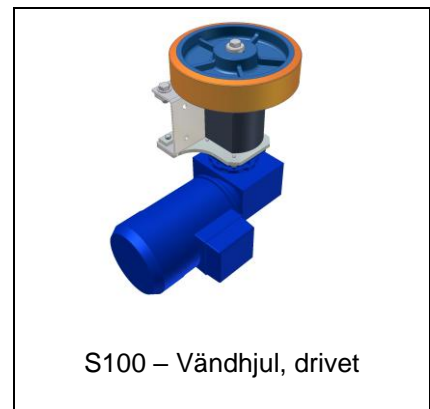

S100 – Vändhjul, drivet



FR100 – Vändare, elektrisk vridrörelse, max 60 kg



KRT100 - Vändare, elektrisk vridrörelse, för kuggremstransportör



KRT100 – Höj- och sänkbar kuggremstransportör med höj- och sänkbar vändplatta

9410



PA1500 – Vändare, elektrisk vridrörelse, för kedjetransportör

10661

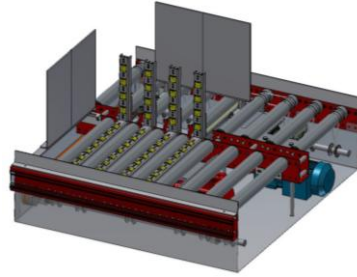

AX100 – Vertikalvändare för att vända godset 90° åt sidan

4639



AX100 – Vertikalvändare, manuell

4029-2



AX100 – Vertikalvändare, elektrisk

7702

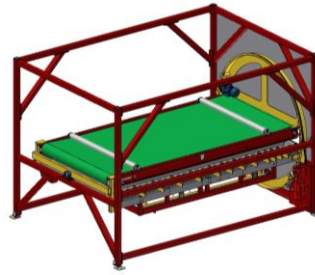

AX100 – Vertikalvändare. Gods kör in på växel, kör ut på rullbana eller vänds och kör ut på bandtrp

4531-1



Flänshjulbana – Vertikalvändare. 3000 kg

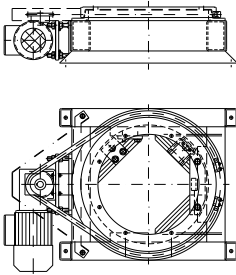

AX100 – Vridmodul, driven

5505-1

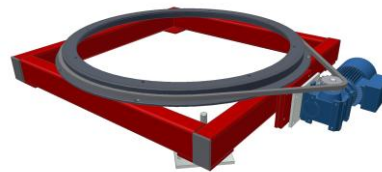

AX100 – Vridmodul, driven

8308

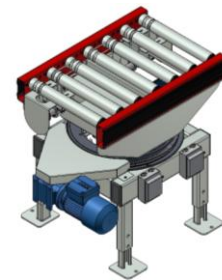

AX100 – Vridbar rullbana

5505-2

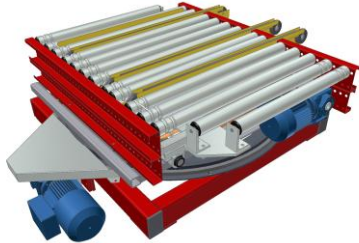

AX100 – Vridmodul med rullbana och vinkelväxel

10897



KE500 – Vridbar rullbana

5947

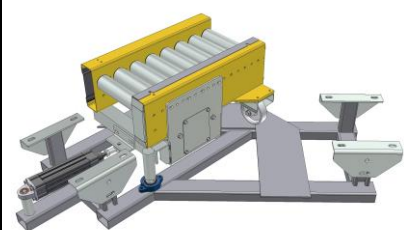

KE500 – Svängmodul, pneumatisk

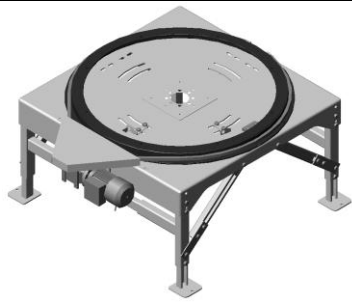

PA1500 – Vridmodul Typ VM *.
Driven

3610

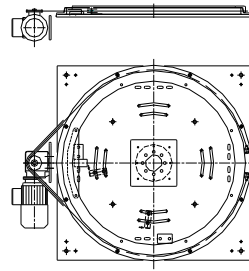

PA1500 – Vridmodul utan ben
och med lös motorhylla

5177

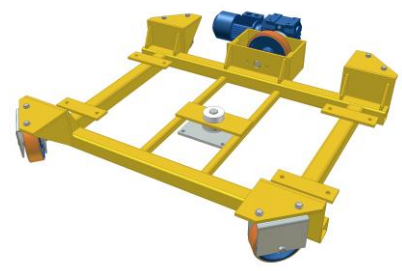

PA1500 – Vridmodul, lågbyggd
med hjul

8419

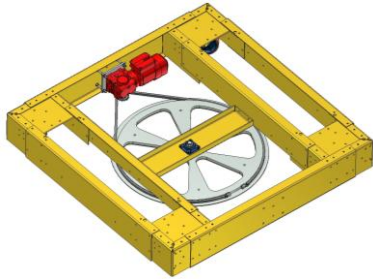

PA1500 – Vridmodul för stor,
tung last, 2600 kg

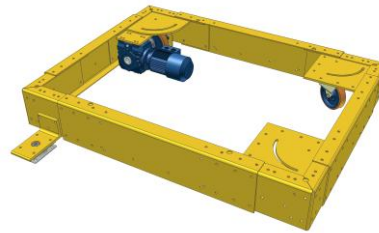

PA1500 – Svängmodul
Typ SM *. Driven



PA1500 – Rullbana, fast driven
för vridmodul Typ VR *

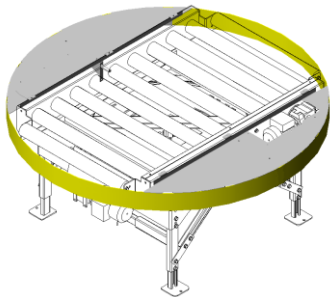

PA1500 – Klämskyddsring till
vridbar rullbana *

9513



PA1500 – Vridbar rullbana med
rulle till rulle drift. Drivning på
samtliga rullar utom stödrullar

10981



PA1500 – Vridbar rullbana,
lågbyggd med hjul. Med
klämskyddsring

7352

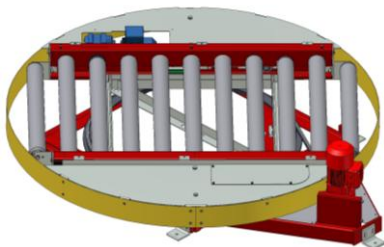

PA1500 – Vridbar rullbana,
lågbyggd. TH 250 mm

7663

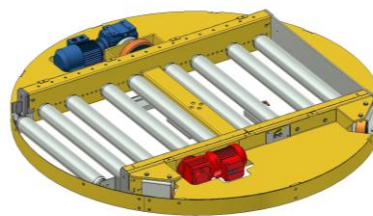

PA1500 – Vridbar rullbana,
lågbyggd med hjul. TH 115 mm

4903



PA1500 – Vridbar rullbana med
vinkelväxel

8233

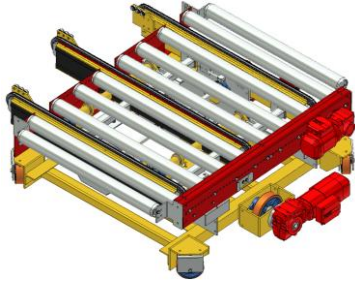

PA1500 – Vridbar rullbana med hjul, med vinkelväxel

5564



PA1500 – Vridmodul, lågbyggd, med rullbana och vinkelväxel. TH 400 mm

6459



PA1500 – Vridbar rullbana med hjul, höj- och sänkbar och med vinkelväxel

6259



PA1500 – Transfervagn med vridbar rullbana

5317

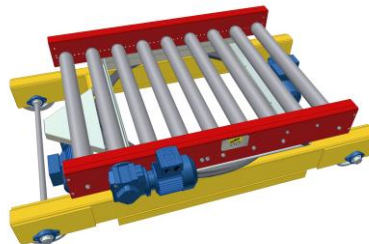

PA1500 – Transfervagn på räl med vridbar rullbana, lågbyggd. TH 430 mm

10619

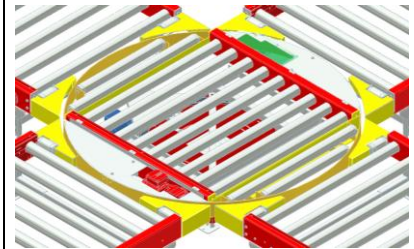

PA1500 – Vridbar rullbana. Stödrullar för godset, med skydd för minskad klämrisik

7275

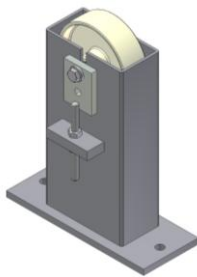

PA1500 – Stödhjul till vridbar rullbana. Minsta TH 400 mm

6804

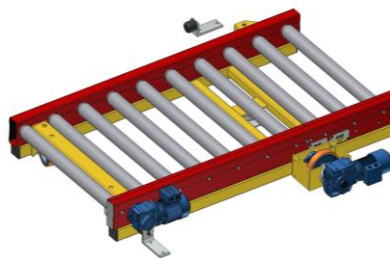

PA1500 – Svängbar rullbana. Lågbyggd, TH 250 mm

9372

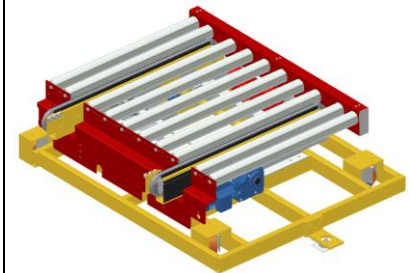

PA1500 – Svängbar rullbana med vinkelväxel

6128

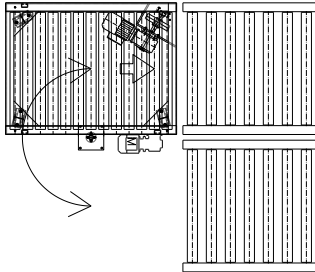

PA1500 – Svängmodul med rullbana använd för att växla över godset från en bana till en annan

7185

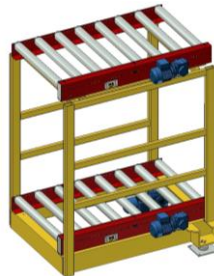

PA1500 – Svängmodul med rullbanor i 2 nivåer

4531-2



Vridmodul, driven

4531-3

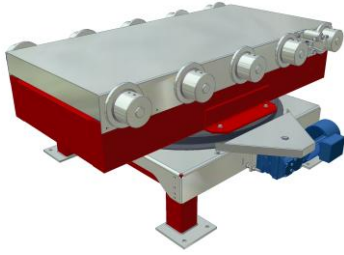

Flänshjulbana – Vridbar
flänshjulbana. 3000 kg

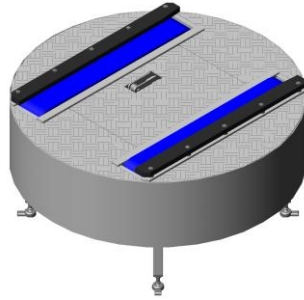

PA1500 Rostfritt – Vridmodul
med 2-strängad
plastlamelltransportör

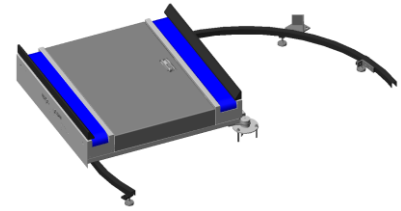

PA1500 Rostfritt – Svängmodul,
driven, med 2-strängad
plastlamelltransportör

